

WALL-MOUNTED WASHBASIN MIXERS: INSTALLATION AND MAINTENANCE INSTRUCTIONS
MISCELATORI DA PARETE PER LAVABO: ISTRUZIONI PER L'INSTALLAZIONE E LA MANUTENZIONE
MITIGEURS MURAUX DE LAVABO: INSTRUCTIONS D'INSTALLATION ET ENTRETIEN
WASCHTISCHARMATUREN FÜR WANDMONTAGE: INSTALLATIONS- UND WARTUNGSANLEITUNG
GRIFERÍA DE PARED PARA LAVABO: INSTRUCCIONES DE INSTALACIÓN Y MANTENIMIENTO

Page 2 - 3



RE002



RE002L

Page 4 - 5



RE003



RE003L

Page 6 - 7



RE012



RE012L

BEFORE STARTING - PRIMA DI INIZIARE - AVANT DE COMMENCER - VOR DEM START - ANTES DE EMPEZAR

<p>P bar</p>	<p>1 MIN MAX 5</p>	<p>3</p>		<p>FILTER TAPS RECOMMENDED</p>
<p>T °C</p>	<p>MAX 70</p>	<p>60 45</p>		

RE002 - RE002L

INSTALLATION - INSTALLAZIONE - INSTALLATION - INSTALLATION - INSTALCIÓN

WALL INSTALLATION - INSTALLAZIONE A PARETE - INSTALLATION MURALE - WANDEINBAU - INSTALCIÓN MURAL

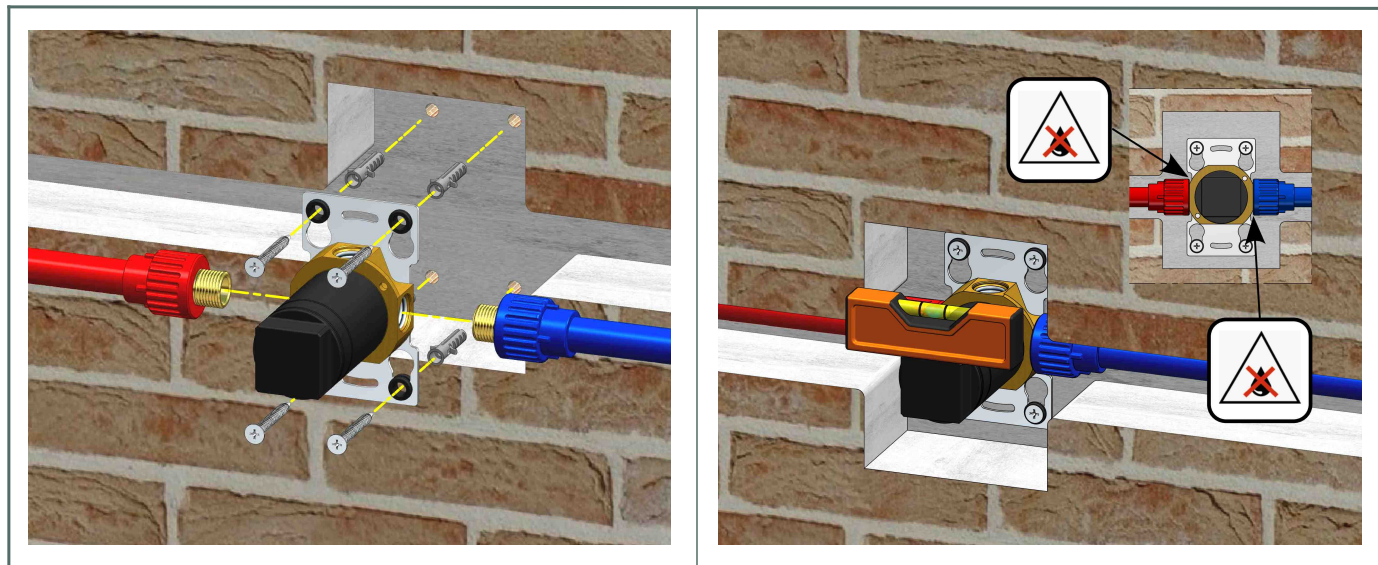

DRYWALL FRAME INSTALLATION - INSTALLAZIONE SU CONTROPARETE - INSTALLATION SUR CLOISON SÈCHE - EINBAU VON TROCKENBAUWÄNDEN - INSTALCIÓN EN PANEL DE CARTÓN YESO

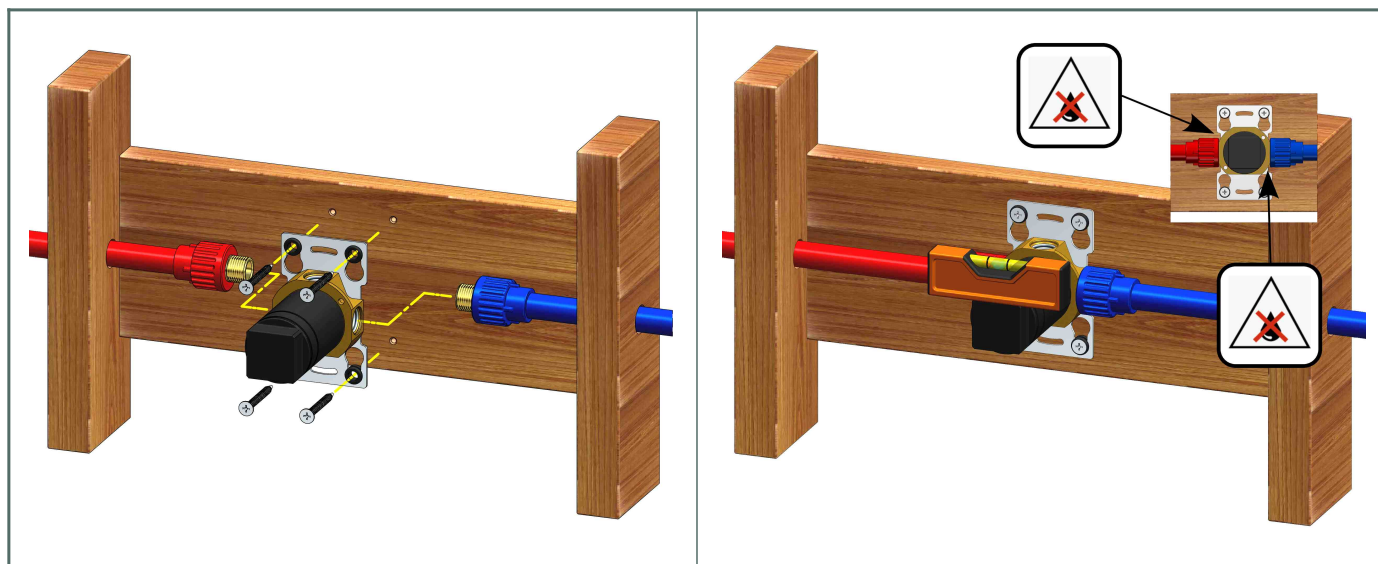

INSTALLATION OF EXTERNAL PARTS - INSTALLAZIONE DELLE PARTI ESTERNE - INSTALLATION DES PARTIES EXTÉRIEURES - EINBAU VON AUFPUTZTEILEN - INSTALCIÓN DE PARTES EXTERNAS

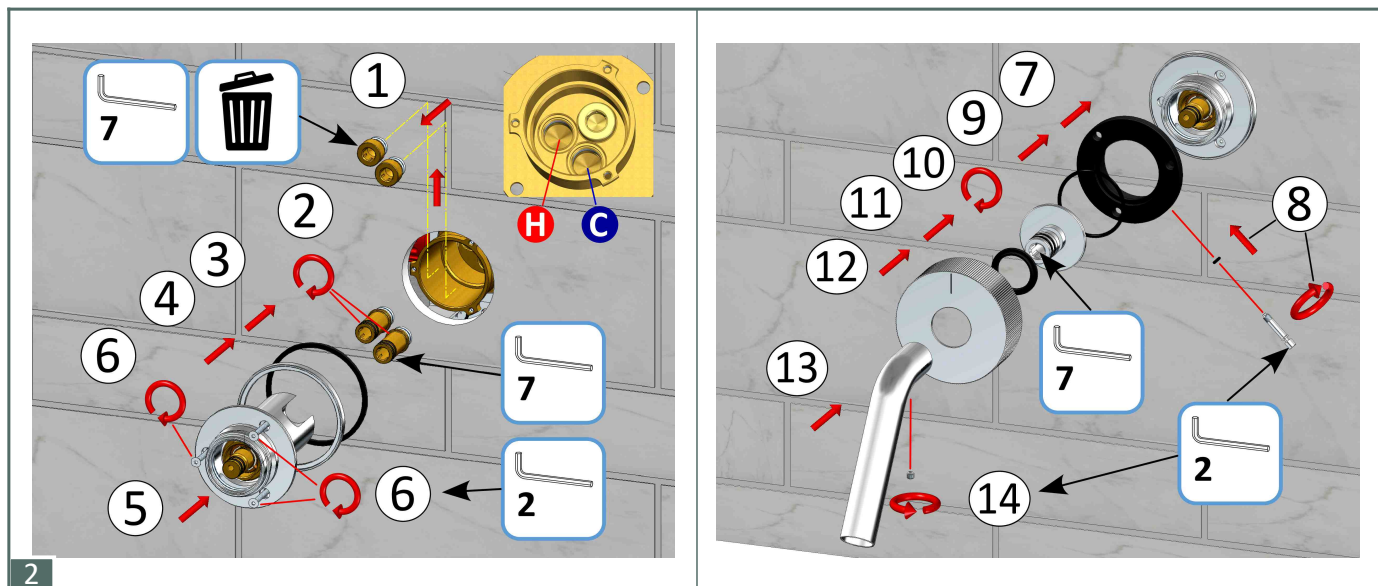

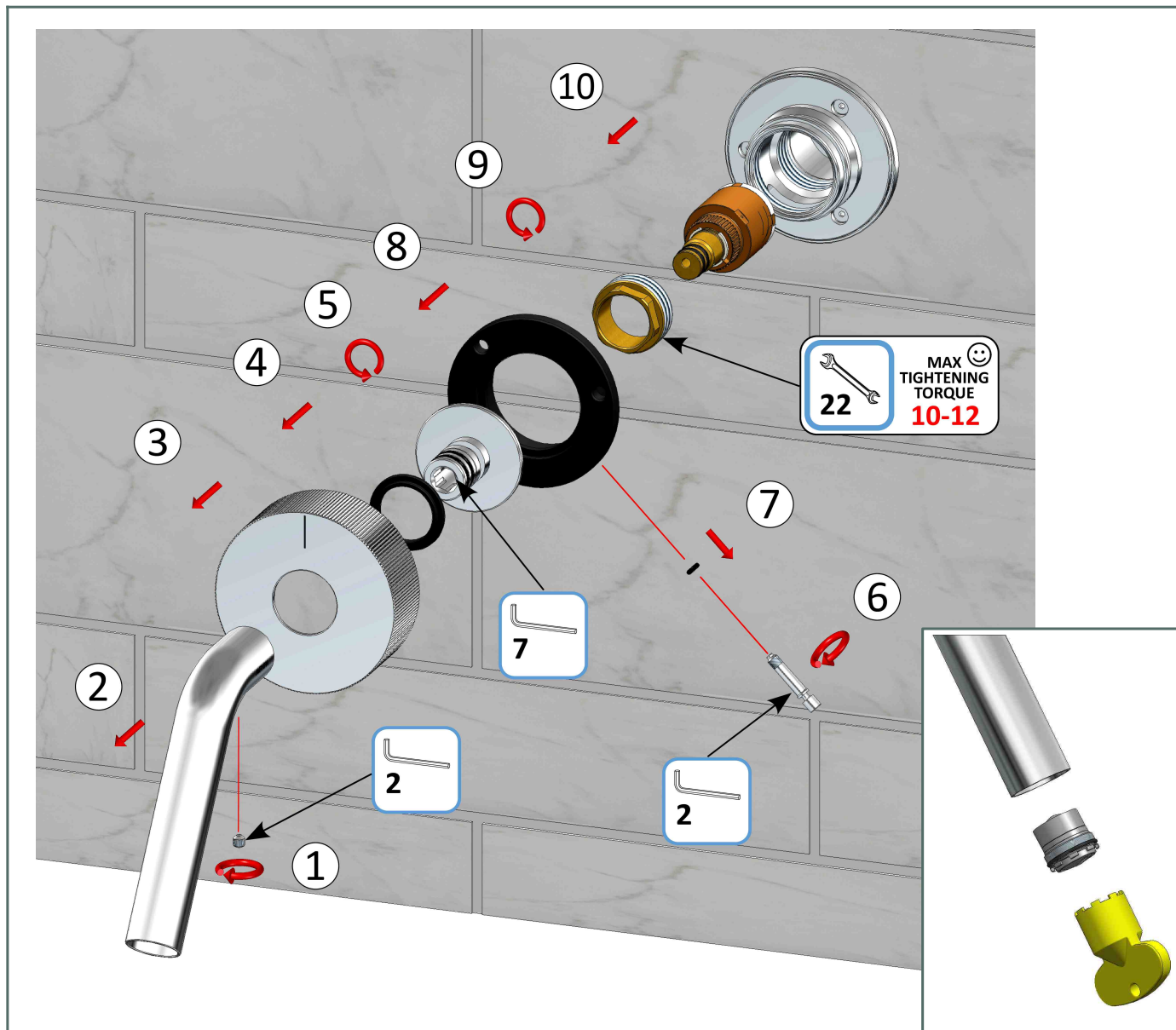

MEASUREMENTS - QUOTE - MESURES - MASSNAHMEN - MEDIDAS

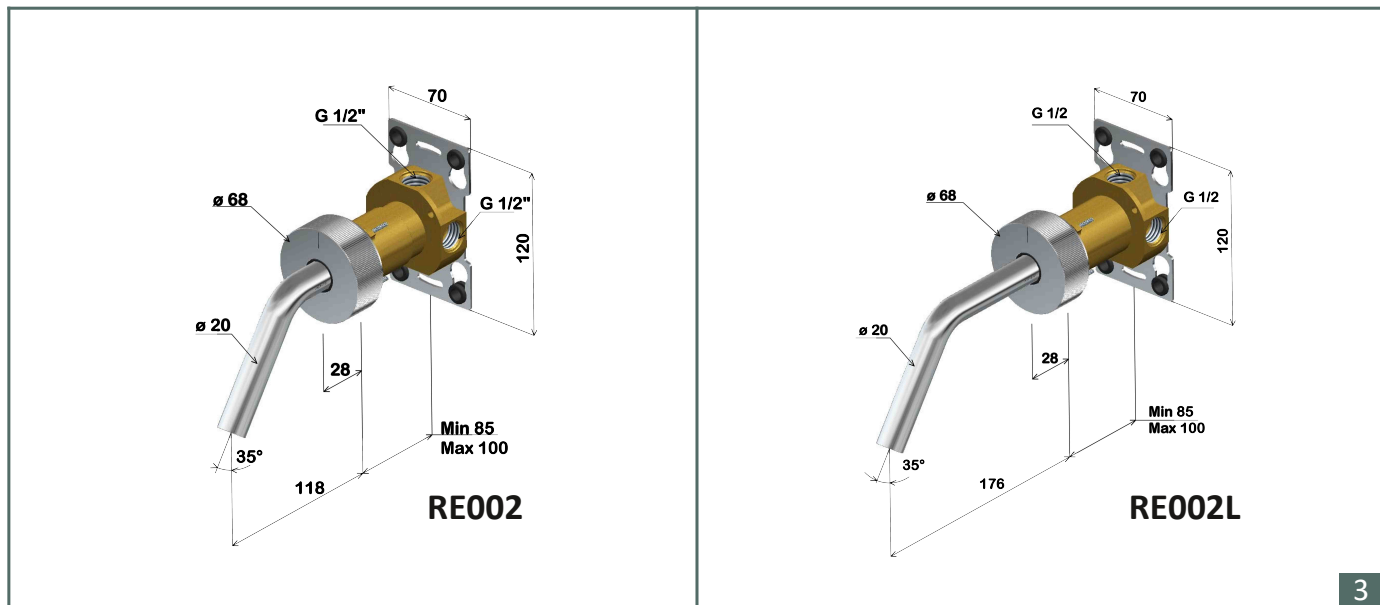

RE003 - RE003L

INSTALLATION - INSTALLAZIONE - INSTALLATION - INSTALLATION - INSTALCIÓN

WALL INSTALLATION - INSTALLAZIONE A PARETE - INSTALLATION MURALE - WANDEINBAU - INSTALCIÓN MURAL

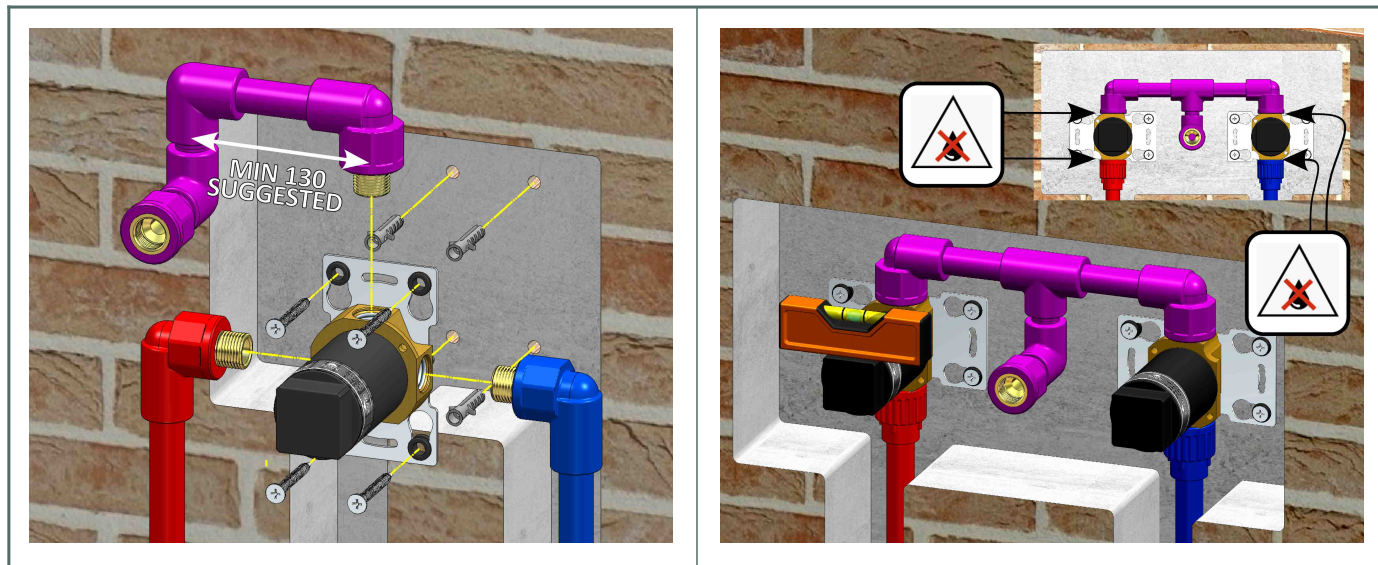

DRYWALL FRAME INSTALLATION - INSTALLAZIONE SU CONTROPARETE - INSTALLATION SUR CLOISON SÈCHE - EINBAU VON TROCKENBAUWÄNDEN - INSTALCIÓN EN PANEL DE CARTÓN YESO

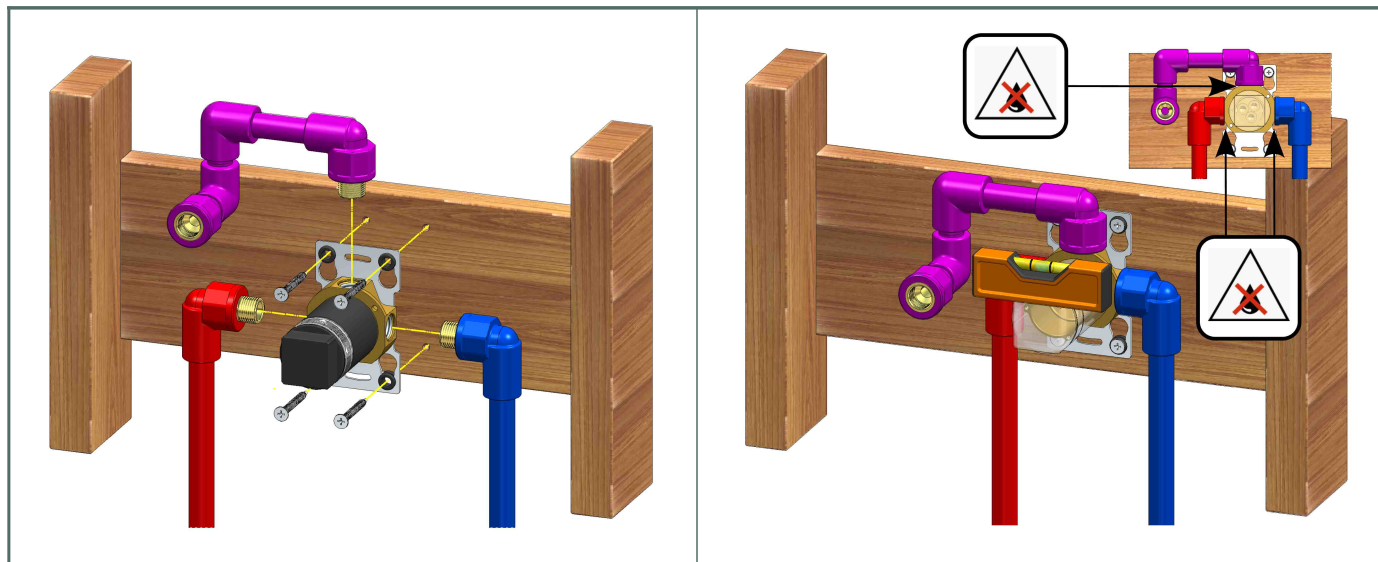

INSTALLATION OF EXTERNAL PARTS - INSTALLAZIONE DELLE PARTI ESTERNE - INSTALLATION DES PARTIES EXTÉRIEURES - EINBAU VON AUFPUTZTEILEN - INSTALCIÓN DE PARTES EXTERNAS

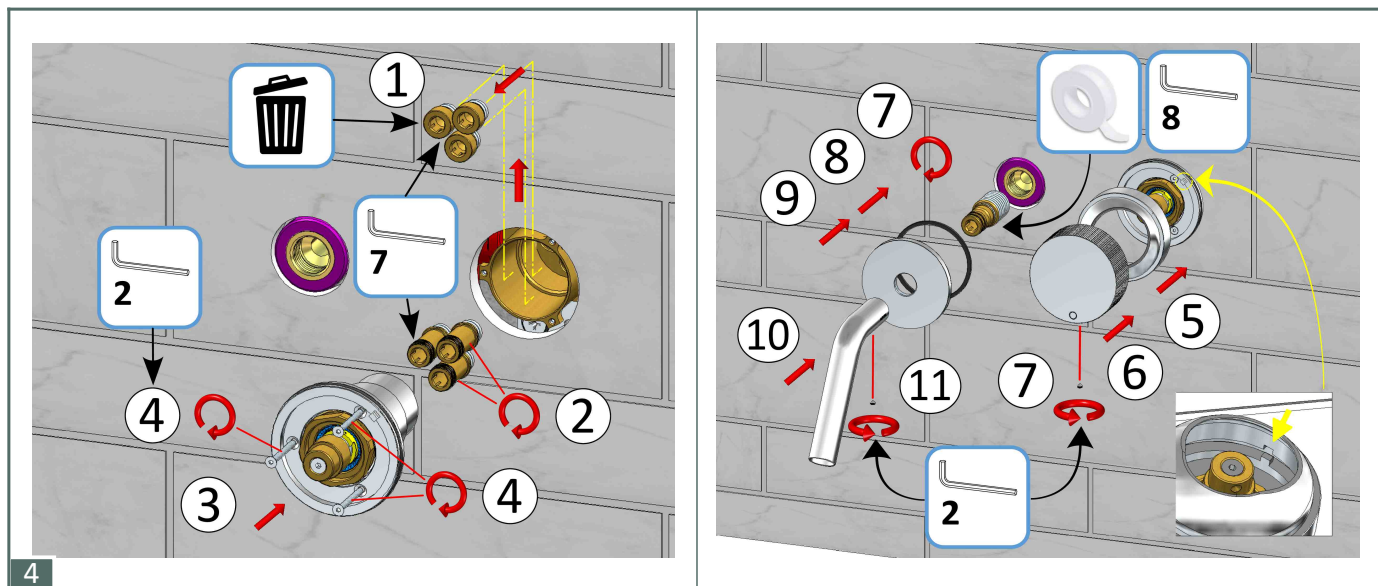

RE012 - RE012L

INSTALLATION - INSTALLAZIONE - INSTALLATION - INSTALLATION - INSTALCIÓN

WALL INSTALLATION - INSTALLAZIONE A PARETE - INSTALLATION MURALE - WANDEINBAU - INSTALCIÓN MURAL

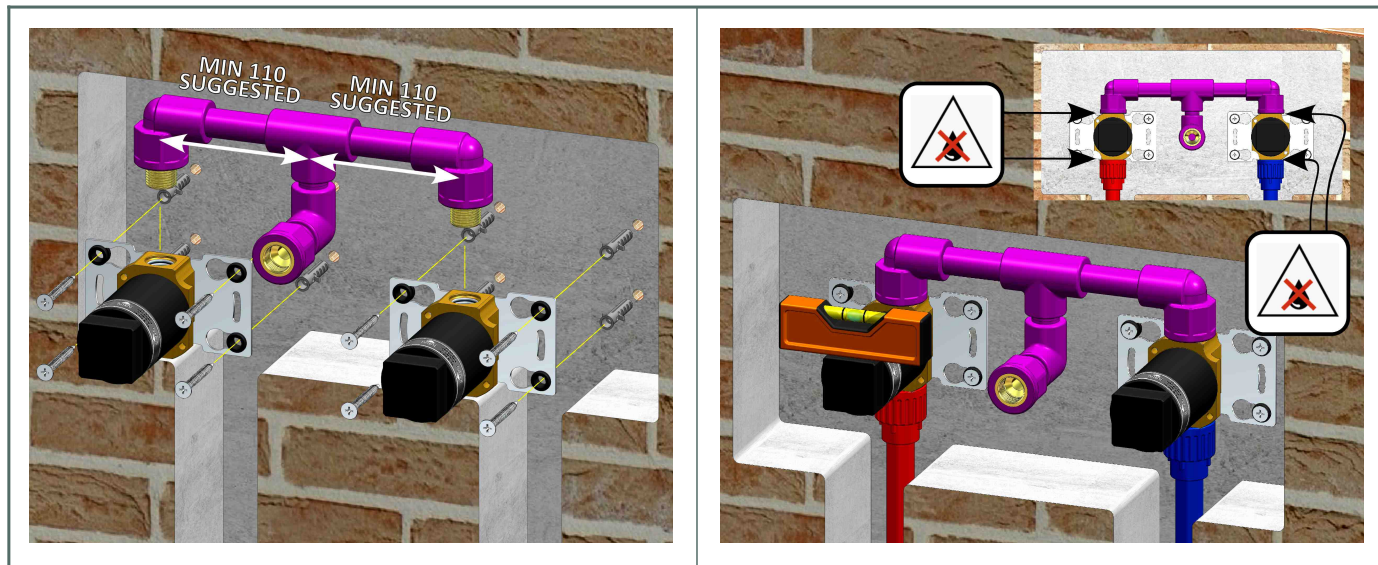

DRYWALL FRAME INSTALLATION - INSTALLAZIONE SU CONTROPARETE - INSTALLATION SUR CLOISON SÈCHE - EINBAU VON TROCKENBAUWÄNDEN - INSTALCIÓN EN PANEL DE CARTÓN YESO

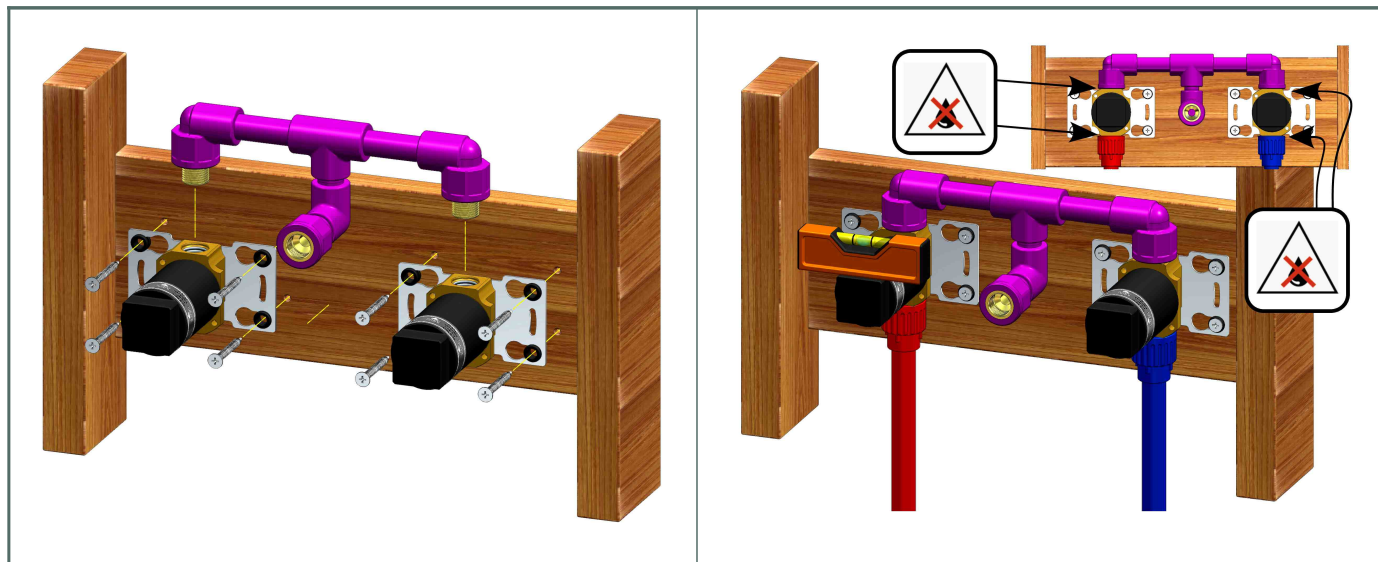

INSTALLATION OF EXTERNAL PARTS - INSTALLAZIONE DELLE PARTI ESTERNE - INSTALLATION DES PARTIES EXTÉRIEURES - EINBAU VON AUFPUTZTEILEN - INSTALCIÓN DE PARTES EXTERNAS

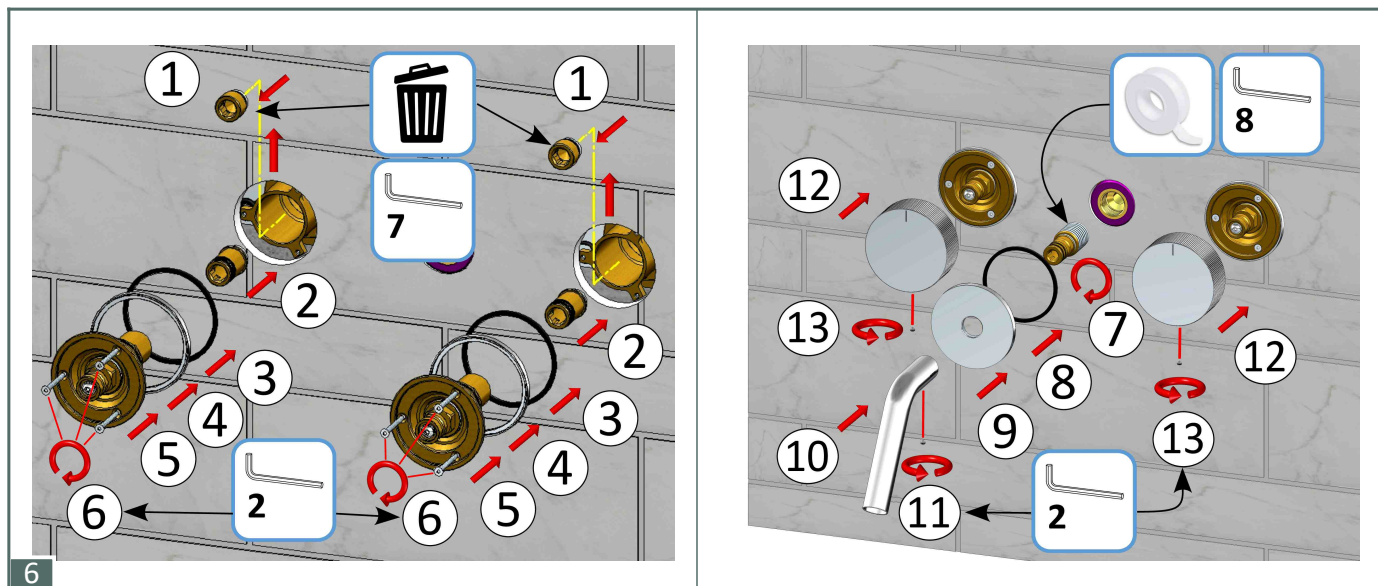

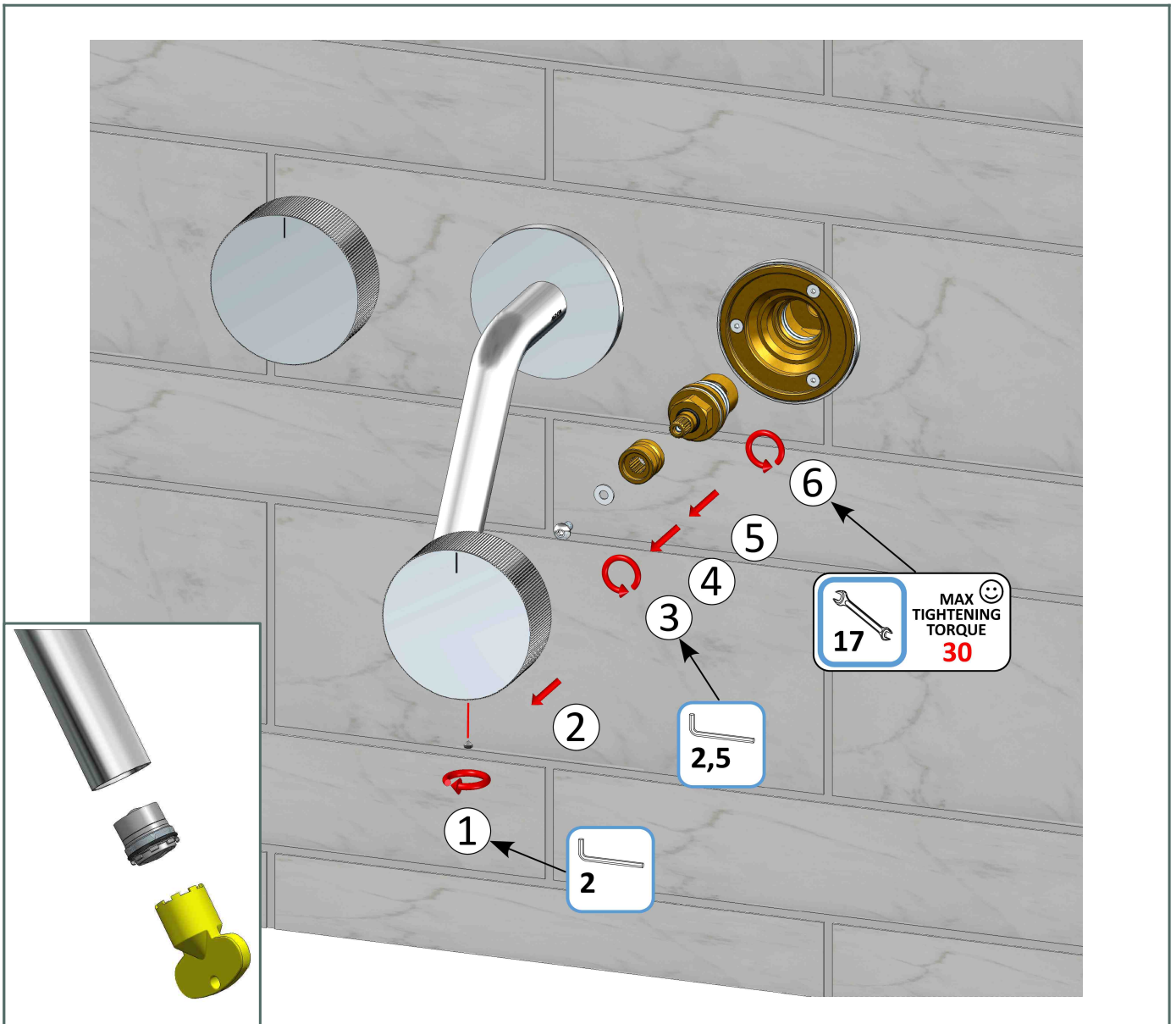



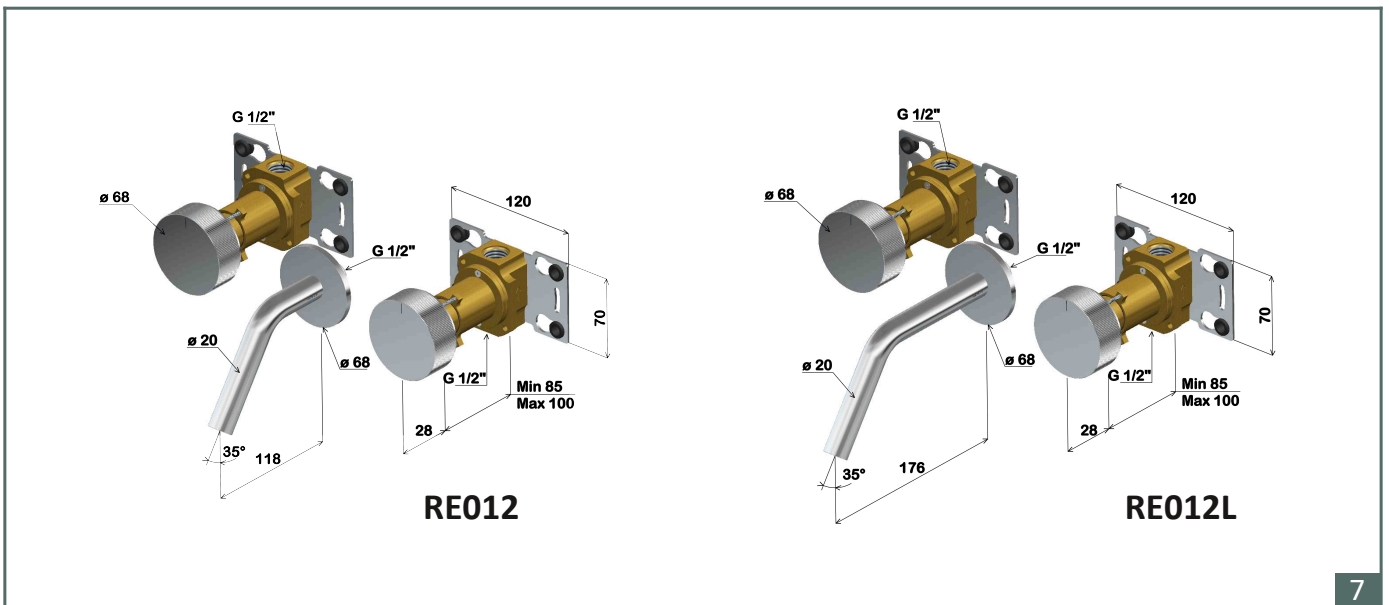











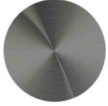

MEASUREMENTS - QUOTE - MESURES - MASSNAHMEN - MEDIDAS





CLEANING - PULIZIA - NETTOYAGE - REINIGUNG - LIMPIEZA

Finish		✓			✗		
BS Brushed Steel 316 stainless steel		 WATER ✓	 LIQUID SOAP ✓	 SMOOTH CLOTH ✓	 ACID/ABRASIVE DETERGENT ✗	 ABRASIVE SPONGE ✗	
	BB Brushed Black PVD finish		 WATER ✓	 LIQUID SOAP ✓	 SMOOTH CLOTH ✓	 ACID/ABRASIVE DETERGENT ✗	 ABRASIVE SPONGE ✗
		BC Brushed Copper PVD finish		 WATER ✓	 LIQUID SOAP ✓	 SMOOTH CLOTH ✓	 ACID/ABRASIVE DETERGENT ✗

AMPHORA
WATER SOURCE

Via dello Statuario 15
I-55045 Pietrasanta - Italy
info@amphoradesign.it